

# Using 3D/Polyline Solids

---

Reference Number: **KB-02925**

Last Modified: **March 29, 2023**

---

## QUESTION

I need to create a custom object, what tool should I use?



## ANSWER

A 3D Solid, also known as a Polyline Solid in X13 and prior versions, is a generic, 3D shape that has a specified thickness. They can be oriented either horizontally or vertically and are useful for creating custom details anywhere in your 3D model.

A horizontal 3D Solid can be created in floor plan view, or any 3D view, by selecting the

3D Solid tool and then clicking and dragging to draw a rectangle. In X13 and prior versions, you can select the Polyline Solid tool instead. A vertical 3D/Polyline Solid can be created in a cross section/elevation view in the same manner as in floor plan view. The 3D/Polyline Solid is placed in front of any objects visible in the view. If no objects are behind, the 3D/Polyline solid is placed one foot in front of the camera.

3D/Polyline Solids can be edited the same way as other closed polyline-based objects.

In this article, a custom shaped mirror will be created.

**Note:** For more information on 3D/Polyline Solids, as well as primitives, please see the [Related Articles](#) section below or the [Moldings, Primitives & 3D CAD \(https://www.chiefarchitect.com/videos/playlists/98/moldings-primitives-3d-cad.html\)](https://www.chiefarchitect.com/videos/playlists/98/moldings-primitives-3d-cad.html) video playlist.

## To create and edit the shape of a 3D/Polyline solid

1. From the menu, select **3D> Create Orthographic View> Cross Section/Elevation**  and create an elevation view.

In this example we are working in a new, blank plan.

2. From this new elevation view, select **Build> Primitive> 3D Solid** , then click and drag to create a rectangular 3D Solid.

In X13 and prior versions, navigate to **Build> Primitive> Polyline Solid**  instead.



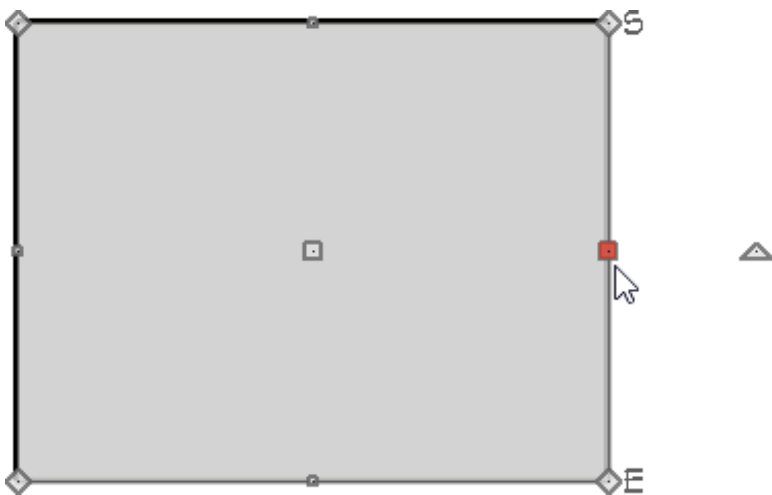

3. Click on one side of the rectangle to activate that side. Notice that the edit handle on that side is now larger than the other sides. The active side is the side that will move when modifying dimensions.

The active edit handle can be a different color than the rest. By default, the handle will be red, but it can be changed on the Colors panel that's located in the Preferences dialog.

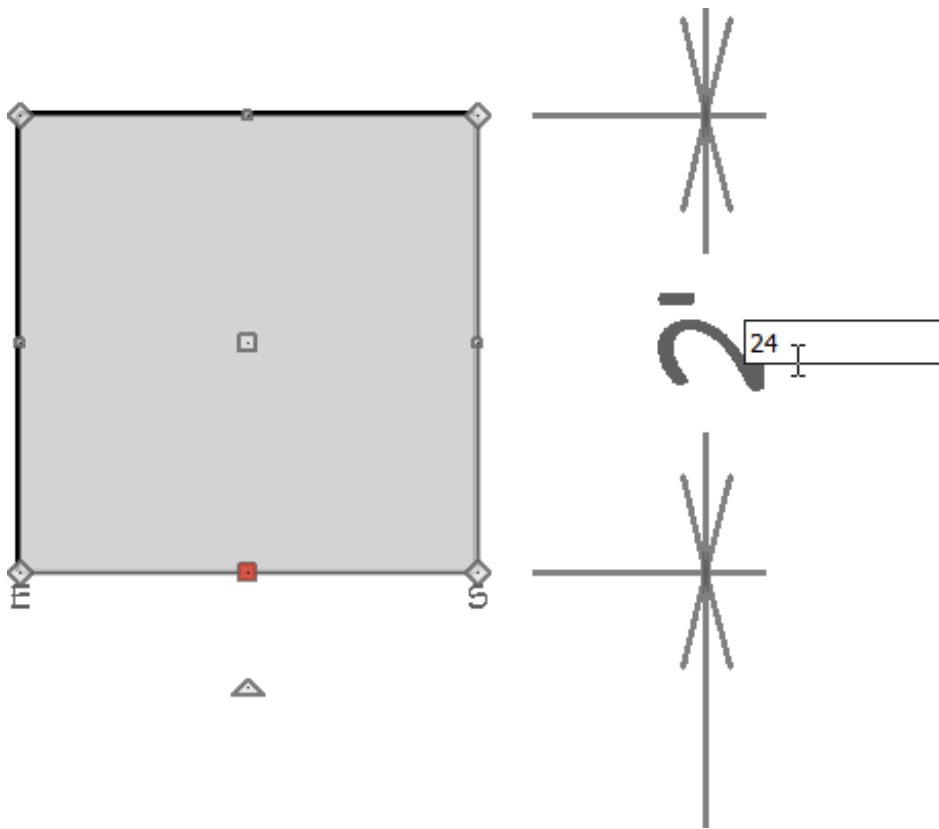

4. Use temporary or manual dimensions to resize the rectangle to a basic **24"** by **24"** square.



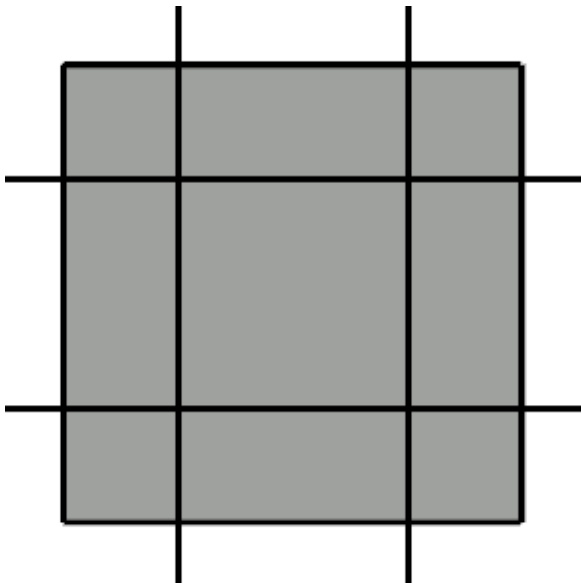

- Next, click **CAD> Lines> Draw Line** , then click and drag to draw four lines across the square **6"** from the sides as shown:



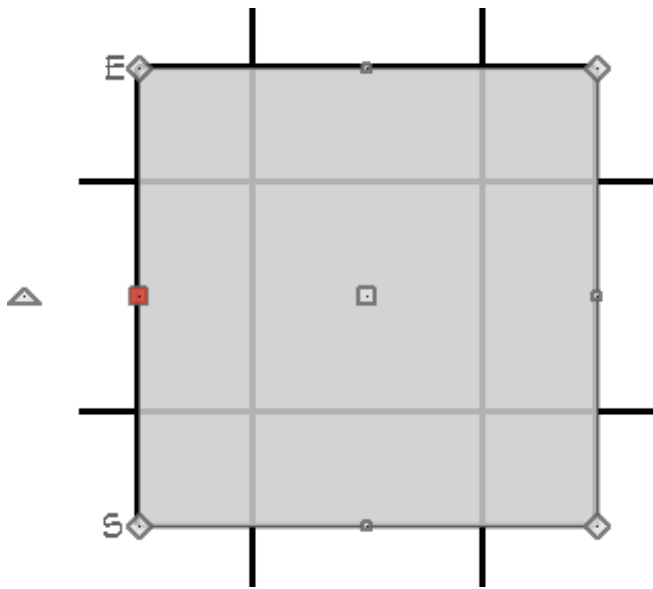

- With the **Select Objects**  tool active, select the 3D/Polyline Solid.



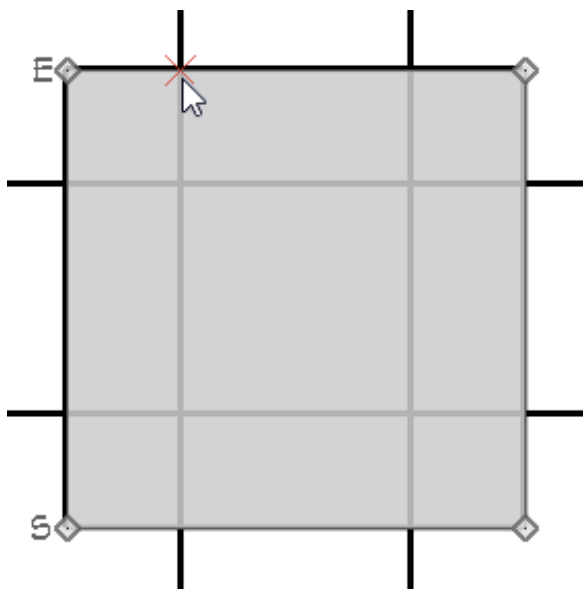

7. On the Edit toolbar, click the **Add Break**  tool and use the **Intersections**  snap indicator to help place break points precisely where the lines intersect the 3D/Polyline Solid.

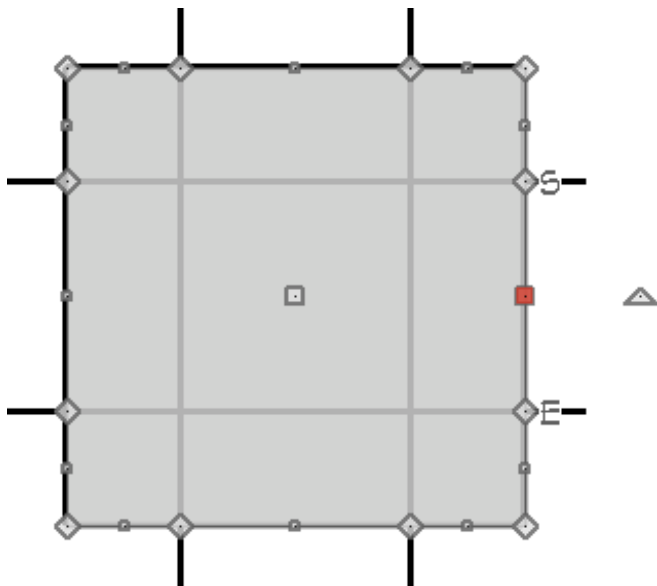

8. Continue making break points at all intersections. Select the **Sticky Mode**  secondary edit tool if you'd like to place multiple break points without having to re-select the **Add Break**  tool each time.



9. Using the **Select Objects**  tool, select the top edge of the 3D/Polyline Solid and click the **Change Line/Arc**  edit button, then use the small triangular edit handle on the edge of the arc to increase the arc's height until it is **6"** tall.

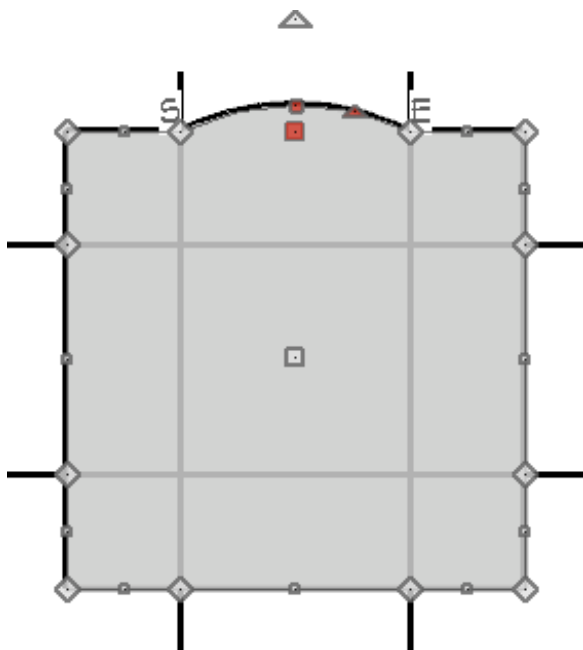

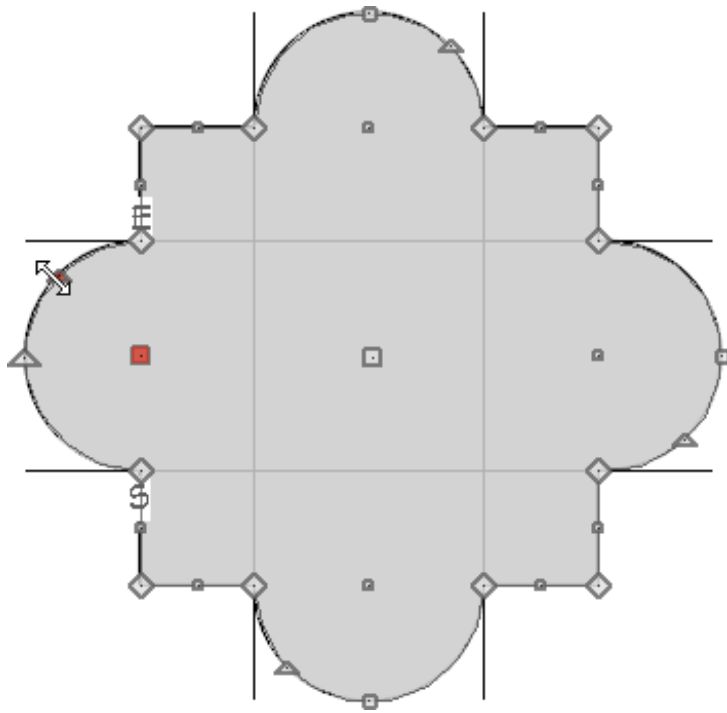

10. Continue using the **Change Line/Arc** edit button to convert the middle sections of each side to arcs of **6"** in height.

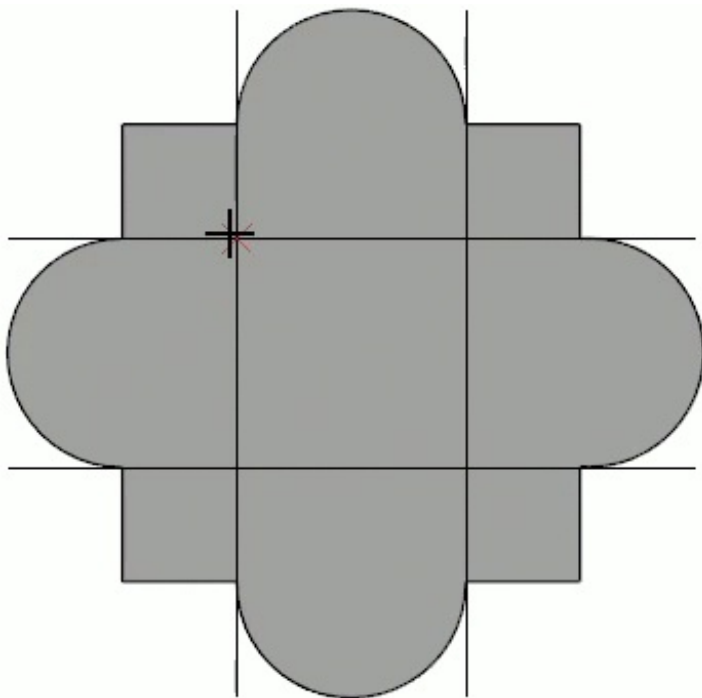

To create a hole in the 3D/Polyline solid

1. Select **CAD> Circles> Circle**  from the menu, and using the CAD line intersections within the 3D/Polyline Solid, click and drag to draw a circle.



2. Select the CAD circle and then click the **Convert Polyline**  edit button.

3. In the **Convert Polyline** dialog, select **3D Solid Hole** option and click **OK**.

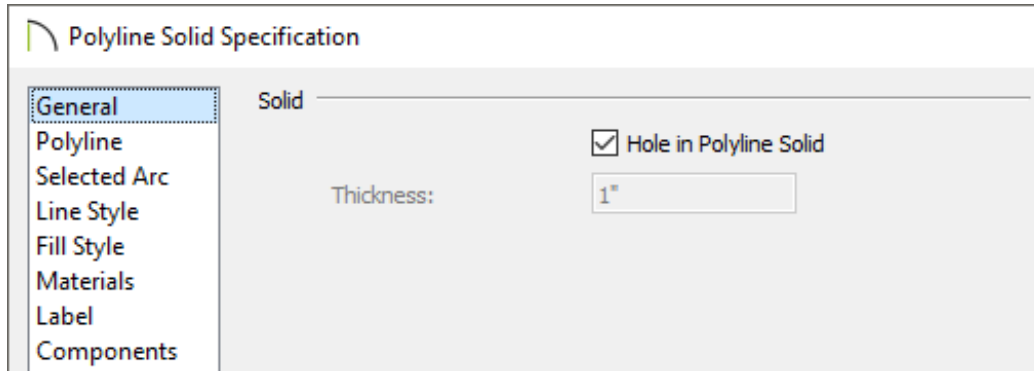

In X13 and prior versions, select **Polyline Solid** instead, then click **OK**.

4. In X13 and prior versions, on the **GENERAL** panel of the **Polyline Solid Specification** dialog, check the **Hole in Polyline Solid** box, then click **OK**.



A hole can also be created by first selecting the 3D/Polyline Solid, selecting the 3D Solid Feature/Create Hole edit tool, then clicking and dragging inside the solid.

## To edit the thickness and material

1. Using the **Select Objects**  tool, select the main 3D/Polyline Solid, then click the **Open Object**  edit button.

2. In the **3D/Polyline Solid Specification** dialog that opens:

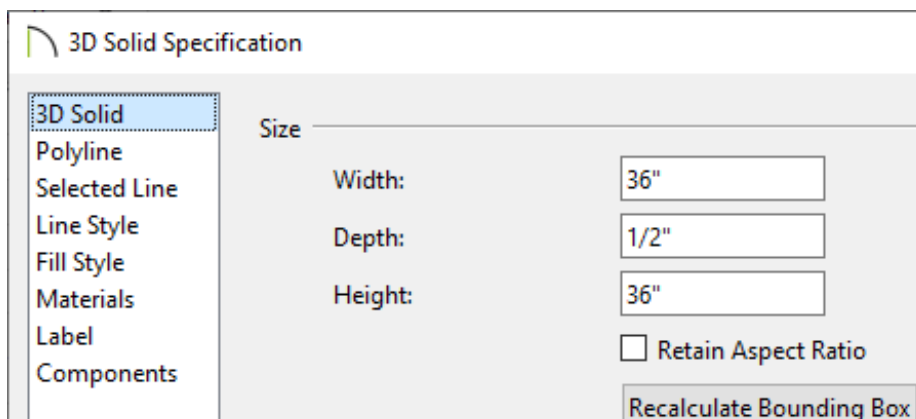

- In X14 and newer versions, on the **3D SOLID** panel, set the Depth to **1/2"**.

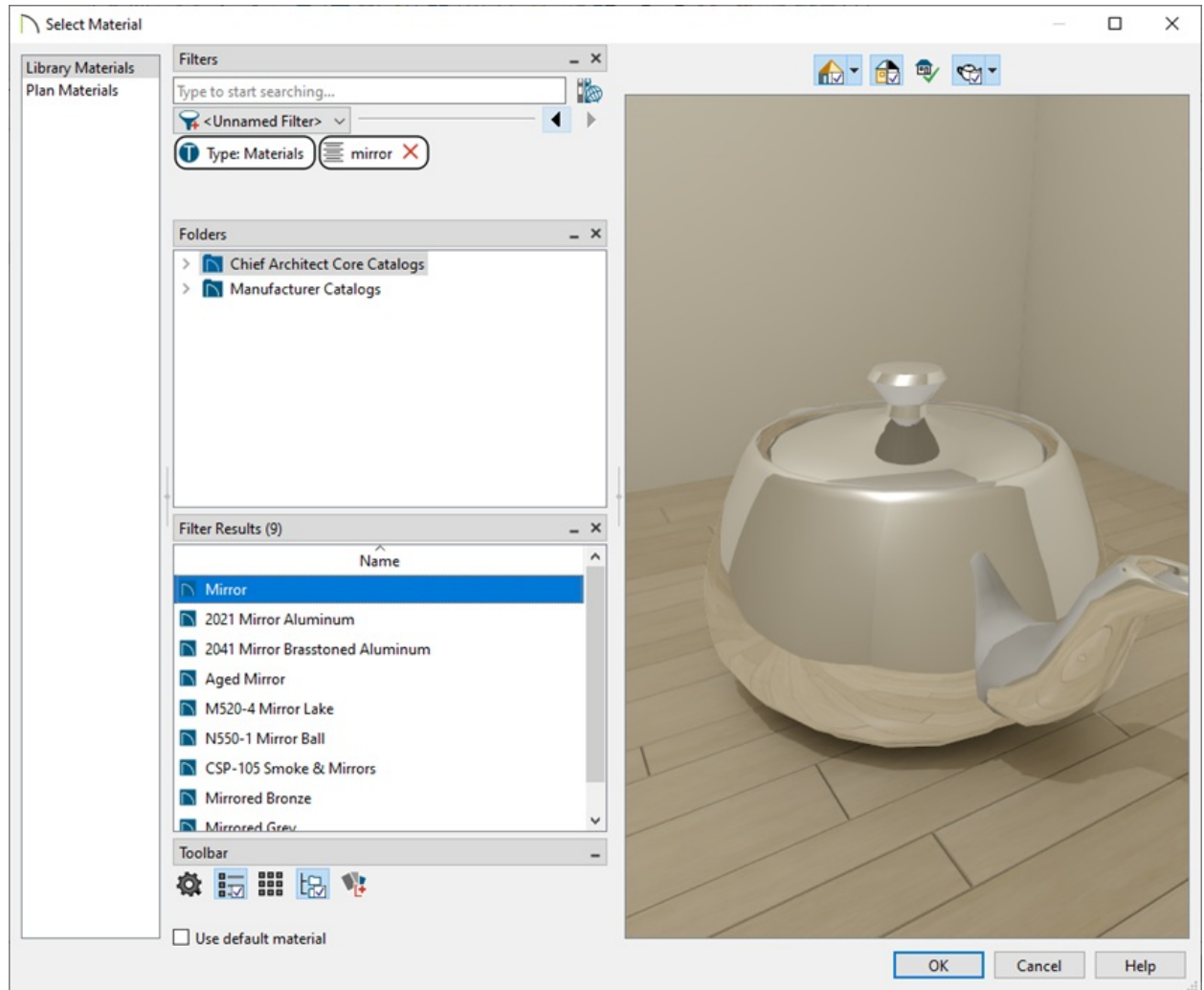

In X13 and prior versions, on the **GENERAL** panel, set the Thickness to **1/2"**.

- On the **MATERIALS** panel, select the **3D/Polyline Solid** sub-component, click the **Select Material** button, then search for a Mirror material.



- Once the desired material is chosen, click **OK** and **OK** a second time to confirm the changes and close both dialogs.

## To add the 3D Solid to your User Catalog

1. Using the **Select Objects**  tool, select your 3D Solid and click on the **Add to Library**  edit button to add the object to the User Catalog.

In X14 prior versions, the 3D/Polyline solid must be part of an architectural block before it can be added to the User Catalog. Please see the "Adding a 3D/Polyline

Solid to the User Catalog" resource in the [Related Articles](#) section for more information.

2. To use this 3D Solid in the future or in a different plan file, select it from your User Catalog and place it into your plan.

## Additional examples created using 3D/Polyline Solids

- Bookends

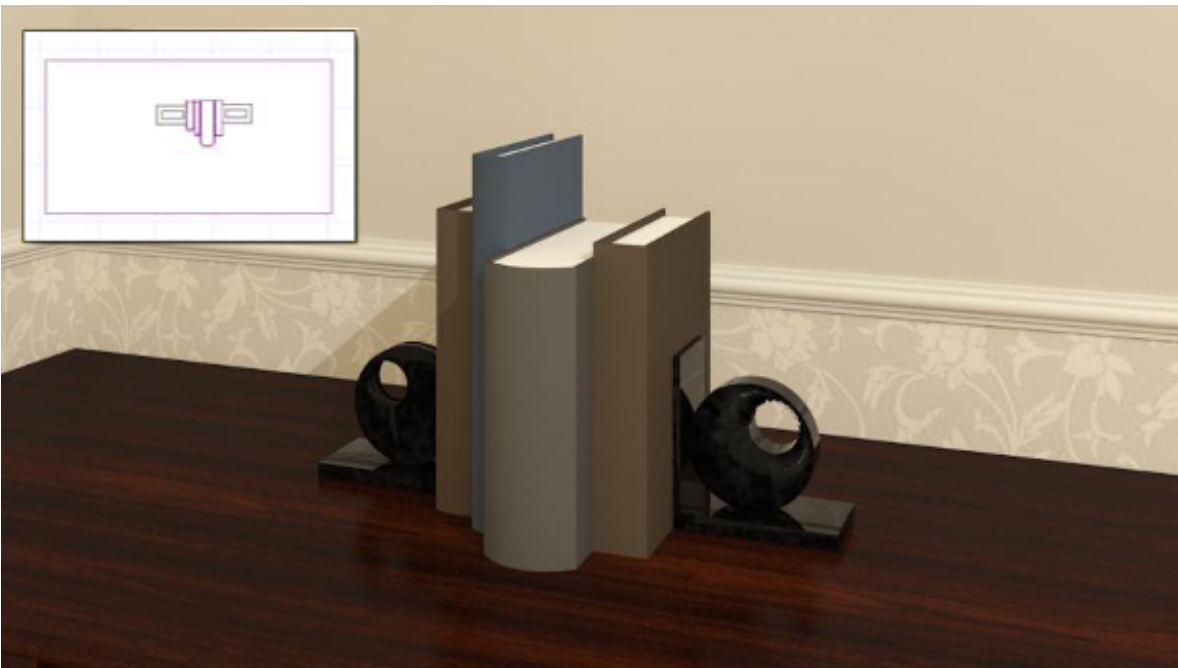

- Gingerbread fachwerk architecture

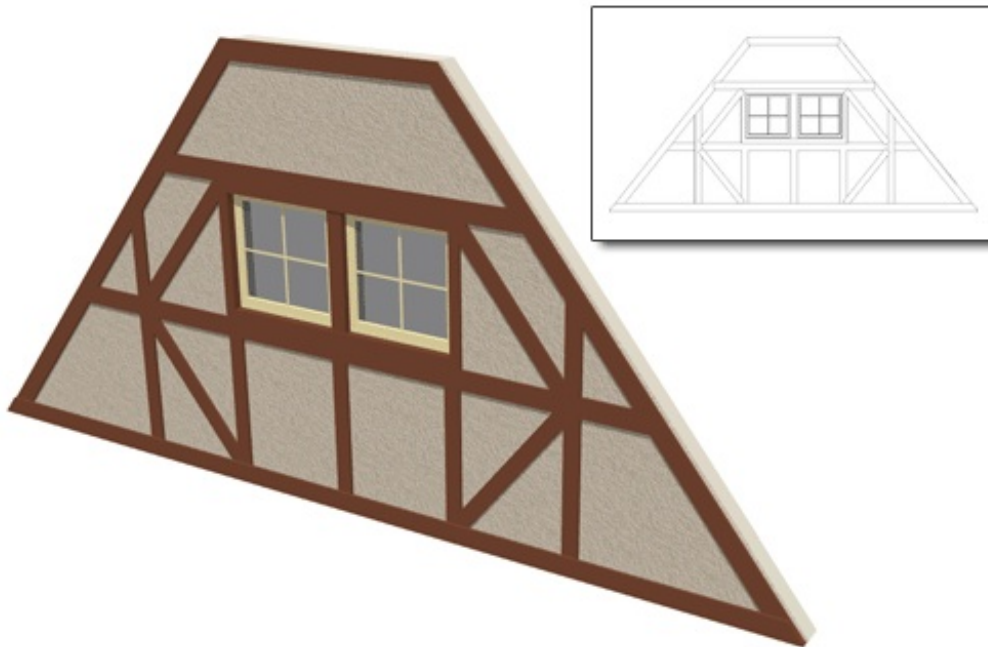

- An arched soldier course

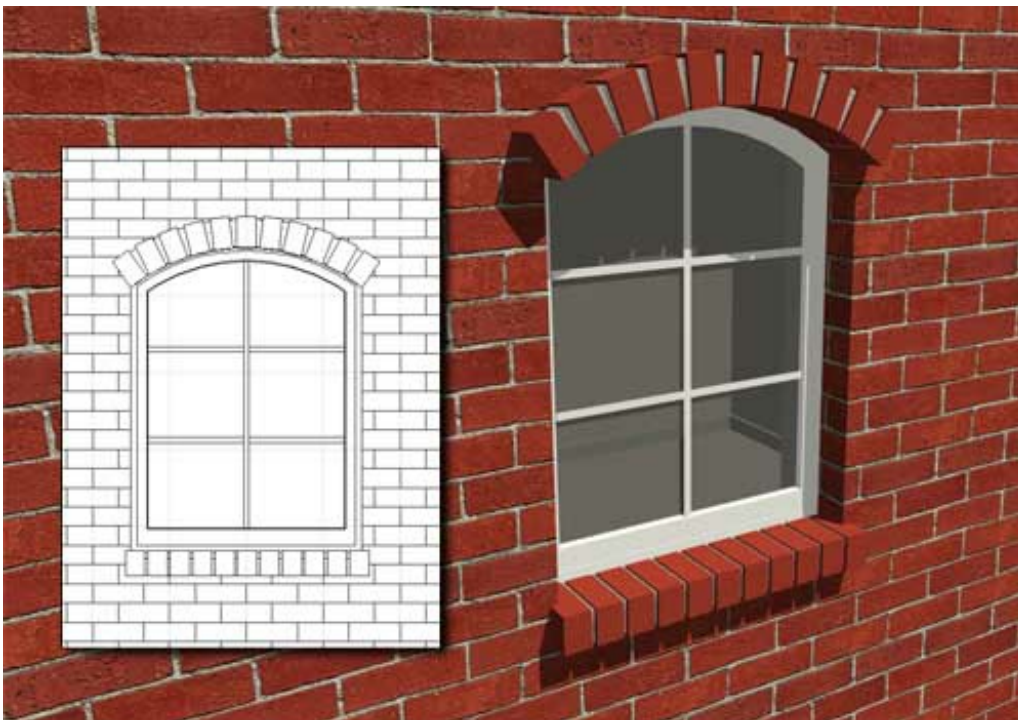

#### Related Articles

- 📄 [Adding a 3D/Polyline Solid to the User Catalog \(/support/article/KB-00035/adding-a-3d-polyline-solid-to-the-user-catalog.html\)](/support/article/KB-00035/adding-a-3d-polyline-solid-to-the-user-catalog.html)
- 📄 [Creating a Custom Arch Using a 3D/Polyline Solid \(/support/article/KB-00565/creating-a-custom-arch-using-a-3d-polyline-solid.html\)](/support/article/KB-00565/creating-a-custom-arch-using-a-3d-polyline-solid.html)
- 📄 [Creating a Custom Door \(/support/article/KB-01808/creating-a-custom-door.html\)](/support/article/KB-01808/creating-a-custom-door.html)
- 📄 [Creating a Sign with 3D Lettering \(/support/article/KB-00709/creating-a-sign-with-3d-](/support/article/KB-00709/creating-a-sign-with-3d-)

[lettering.html](#))

📄 [Creating a Soldier Course \(/support/article/KB-00797/creating-a-soldier-course.html\)](/support/article/KB-00797/creating-a-soldier-course.html)

📄 [Creating Custom Balusters and Railing Panels \(/support/article/KB-02893/creating-custom-balusters-and-railing-panels.html\)](/support/article/KB-02893/creating-custom-balusters-and-railing-panels.html)

📄 [Modeling Custom 3D Objects \(/support/article/KB-00761/modeling-custom-3d-objects.html\)](/support/article/KB-00761/modeling-custom-3d-objects.html)

📄 [Using the Extrude Object Edit Tool \(/support/article/KB-00931/using-the-extrude-object-edit-tool.html\)](/support/article/KB-00931/using-the-extrude-object-edit-tool.html)



[\(https://chieftalk.chiefarchitect.com/\)](https://chieftalk.chiefarchitect.com/)

📄 [\(/blog/\)](/blog/)



[\(/https://www.facebook.com/ChiefArchitect\)](https://www.facebook.com/ChiefArchitect)



[\(/https://www.youtube.com/user/ChiefArchitectInc\)](https://www.youtube.com/user/ChiefArchitectInc)



[\(/https://www.instagram.com/chiefarchitect/\)](https://www.instagram.com/chiefarchitect/)



[\(/https://www.houzz.com/pro/chiefarchitect/\)](https://www.houzz.com/pro/chiefarchitect/)



[\(/https://www.pinterest.com/chiefarchitect/\)](https://www.pinterest.com/chiefarchitect/)